

# FCS USER FLOWS

## "DOWNLOAD APP"

From website & App Stores

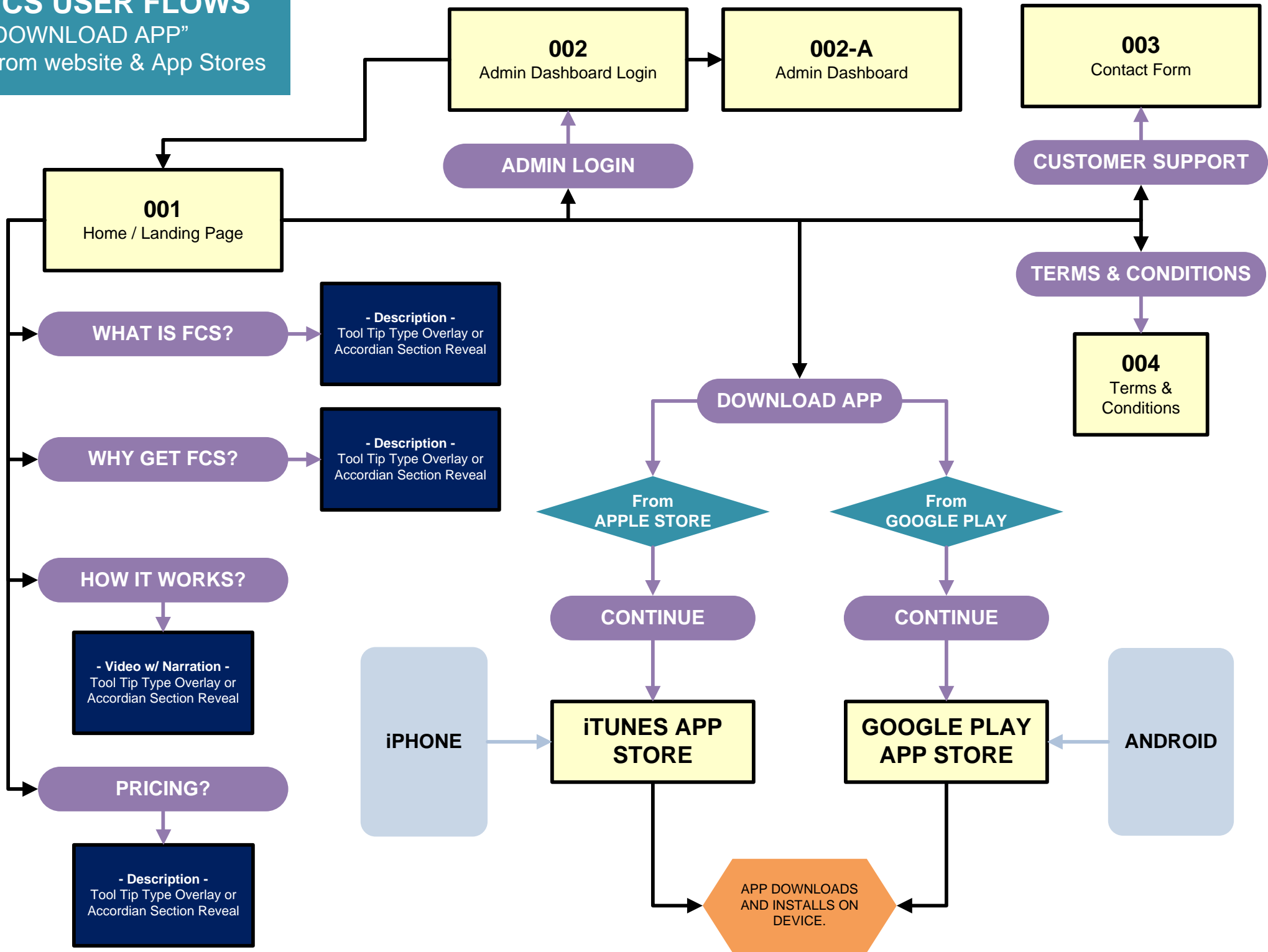

# FCS USER FLOWS

## Site Map

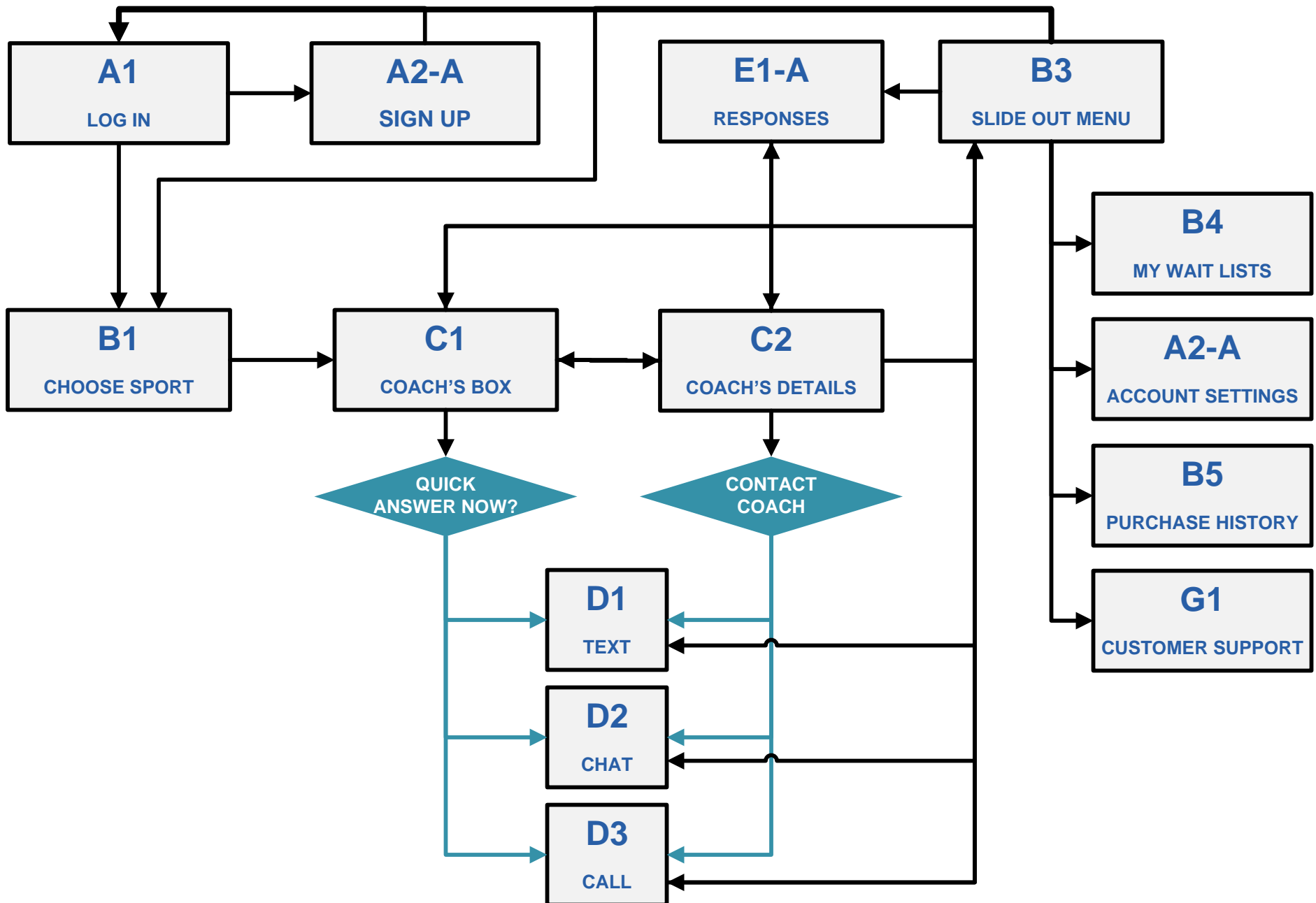

# FCS USER FLOWS

User & Coach  
Login / Sign Up

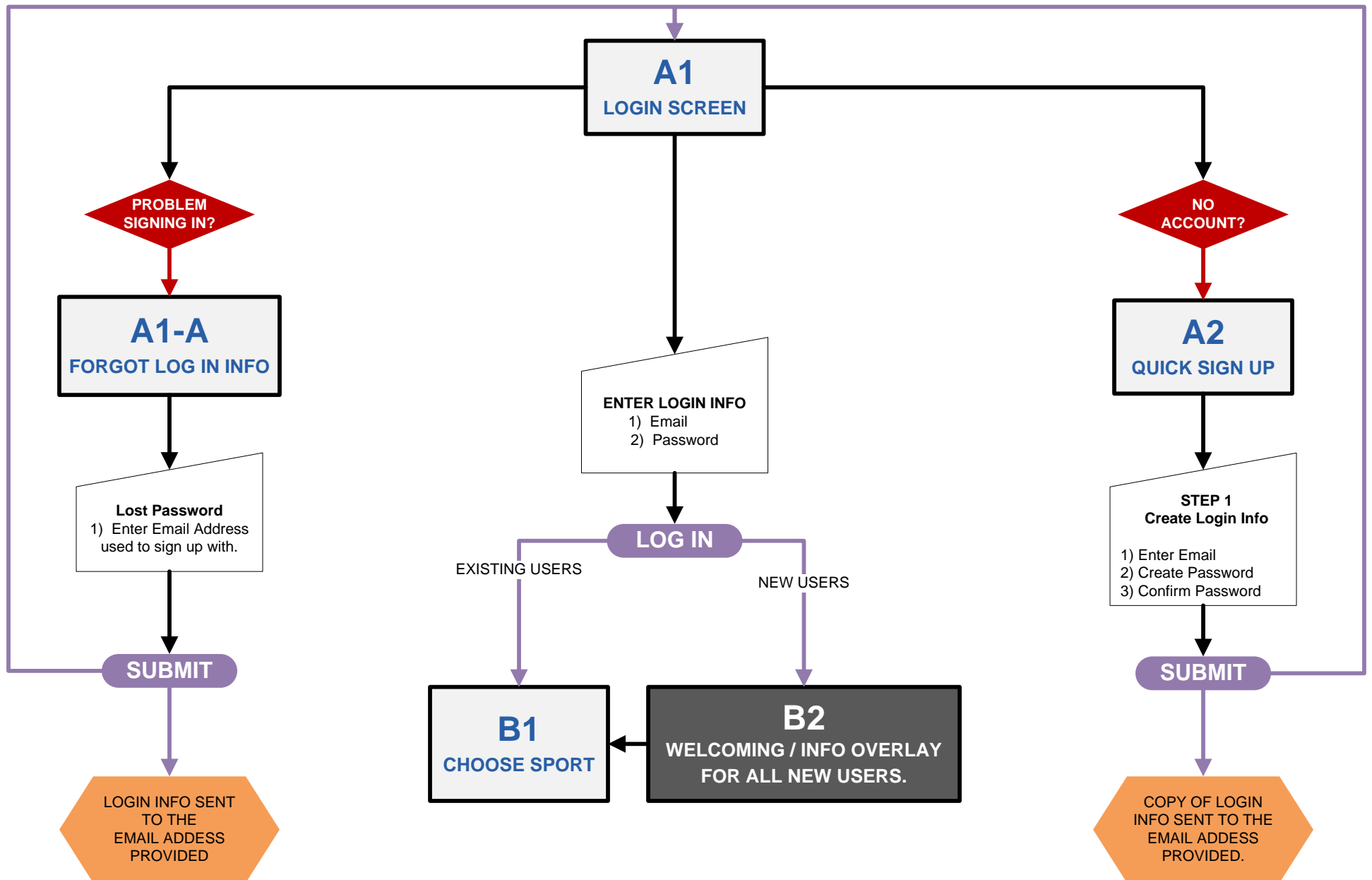

# FCS USER FLOWS

User Coach's Box /  
Coach's Details

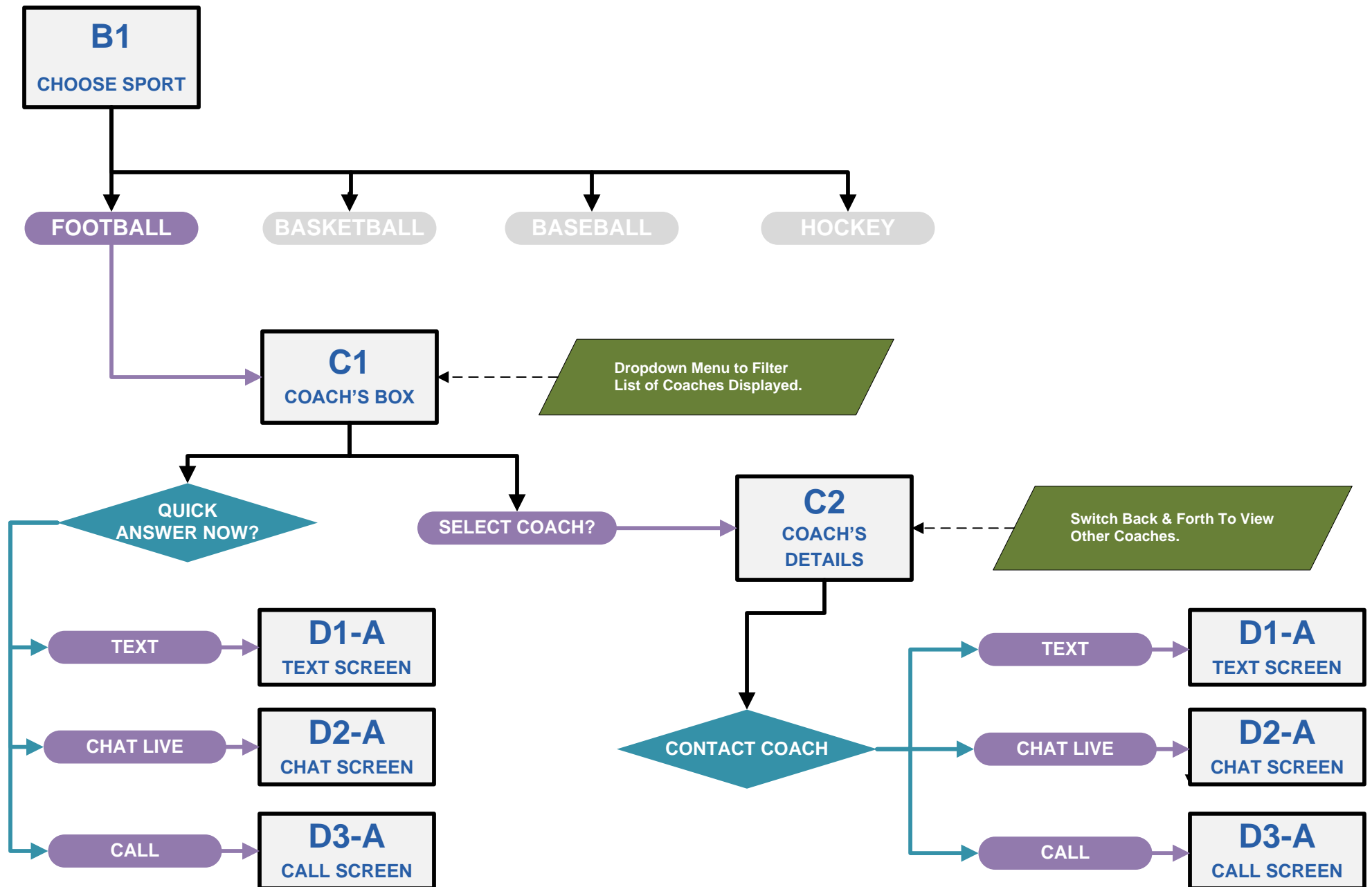

# FCS USER FLOWS

Text Correspondences  
with Coaches

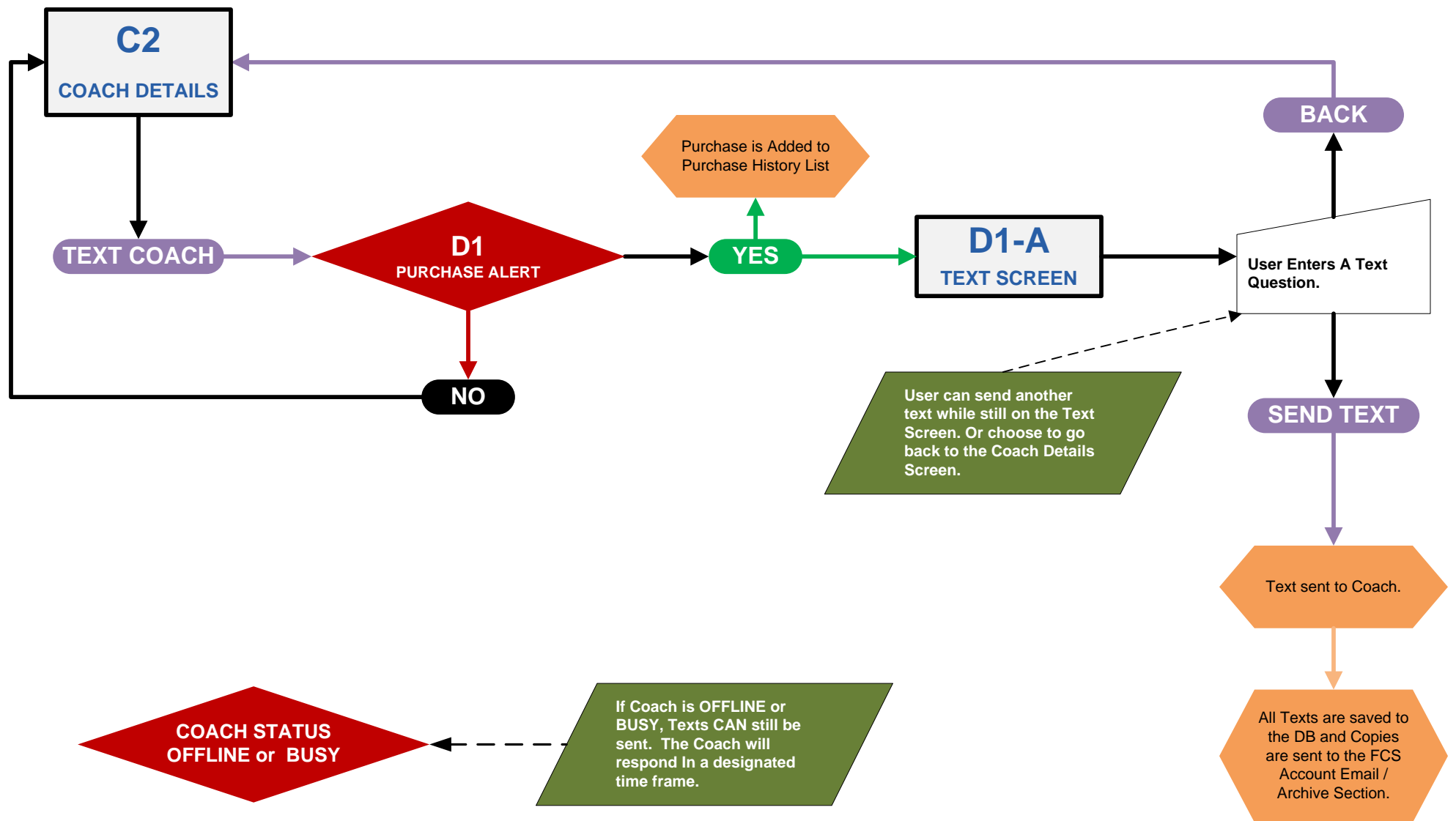

# FCS USER FLOWS

"Chat Live" with a Coach

(Coach is Available)

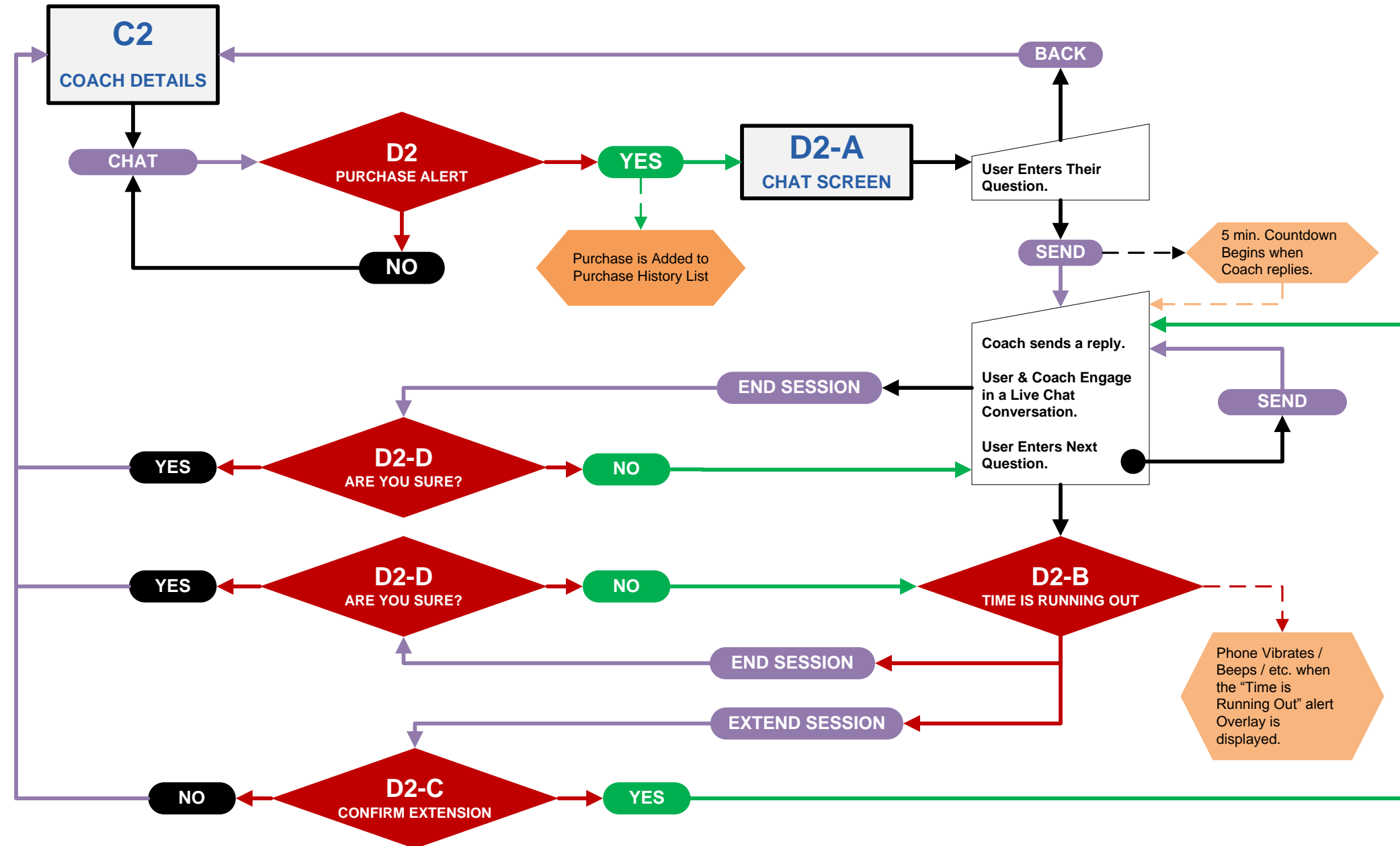

# FCS USER FLOWS

“Chat Live” with a Coach

(Coach is Busy / Offline)

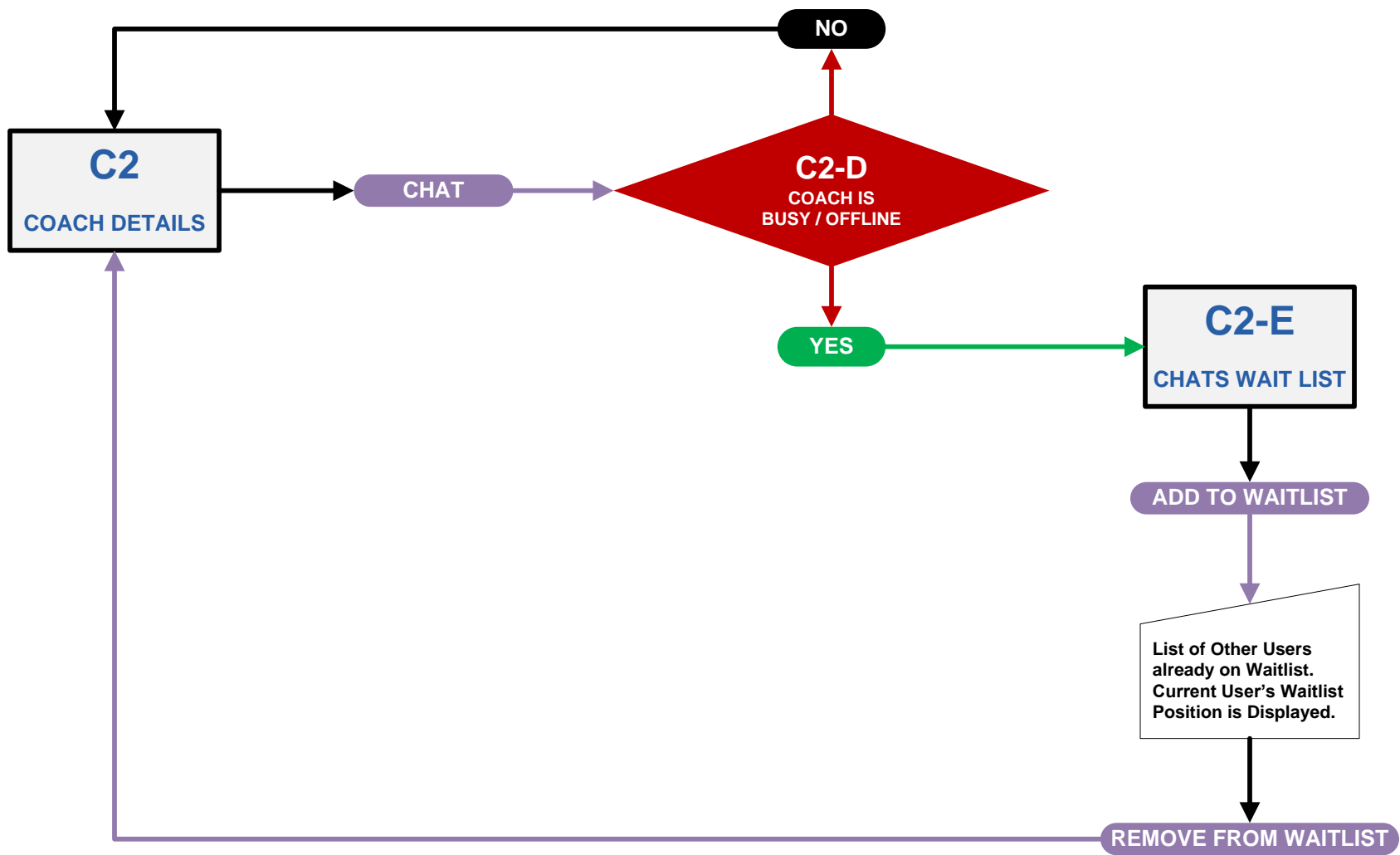

# FCS USER FLOWS

Call a Coach  
(Coach is Available)

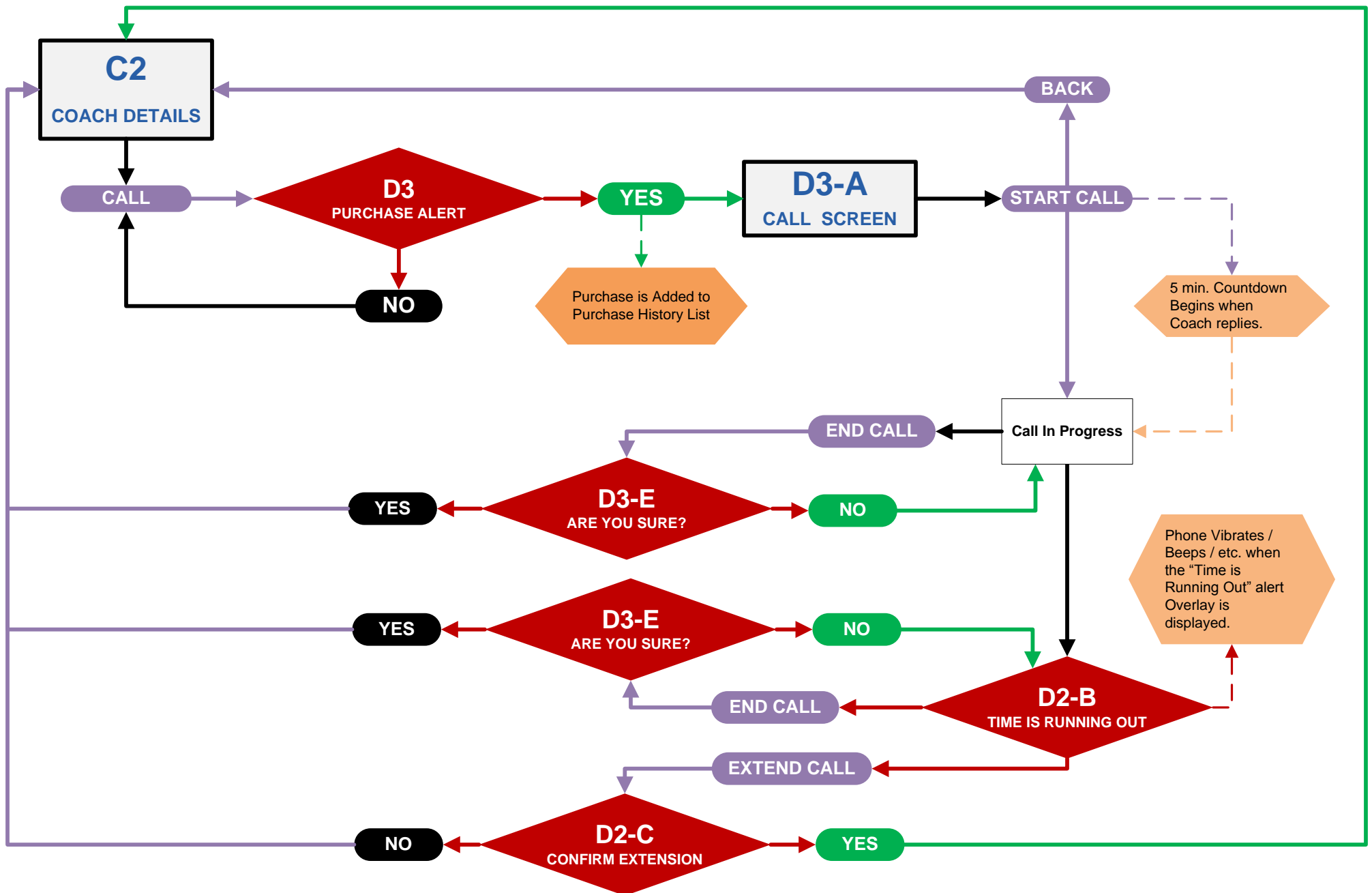



# FCS USER FLOWS

Call a Coach  
(Coach is Busy)

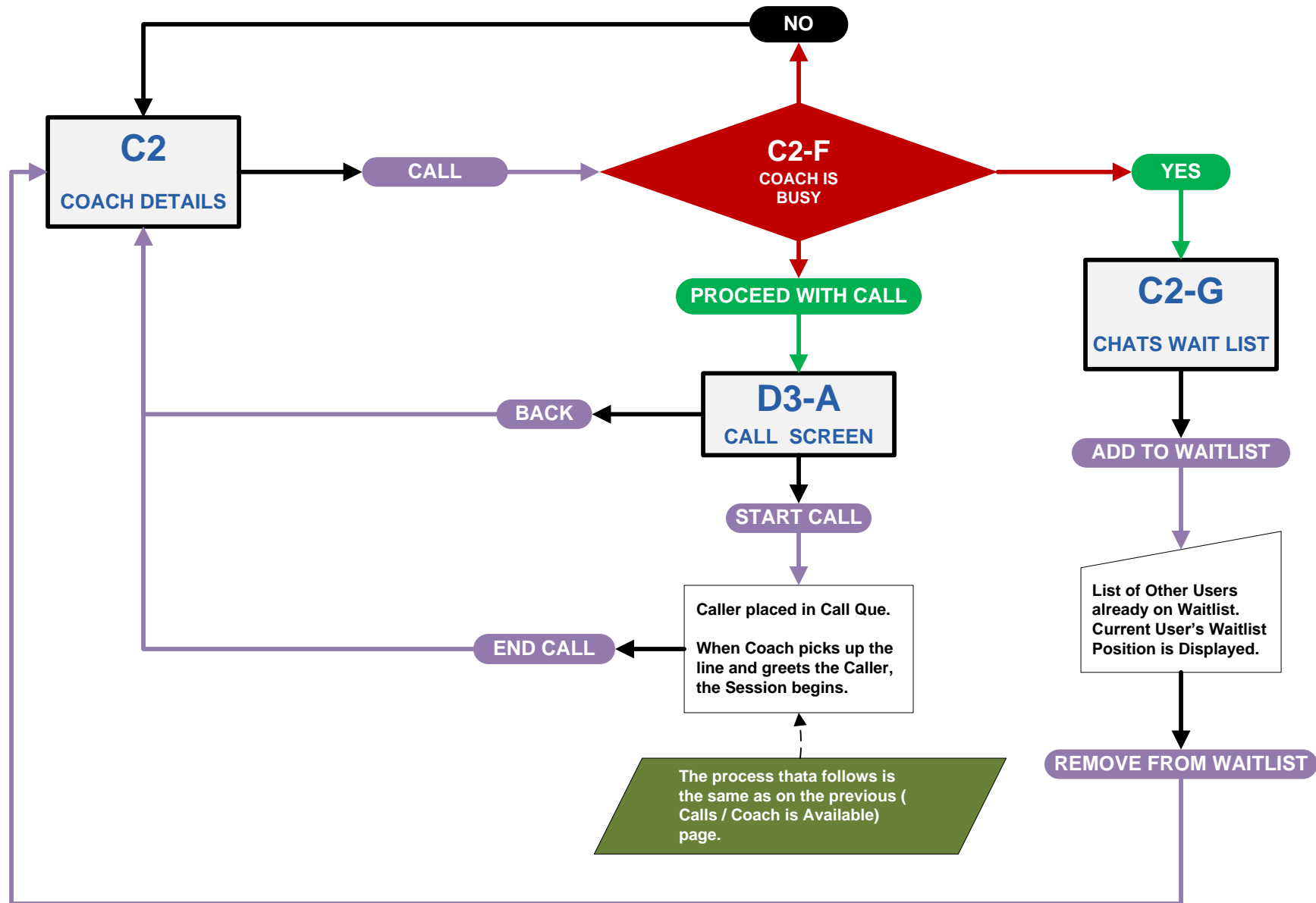

# FCS USER FLOWS

Call a Coach  
(Coach is Offline)

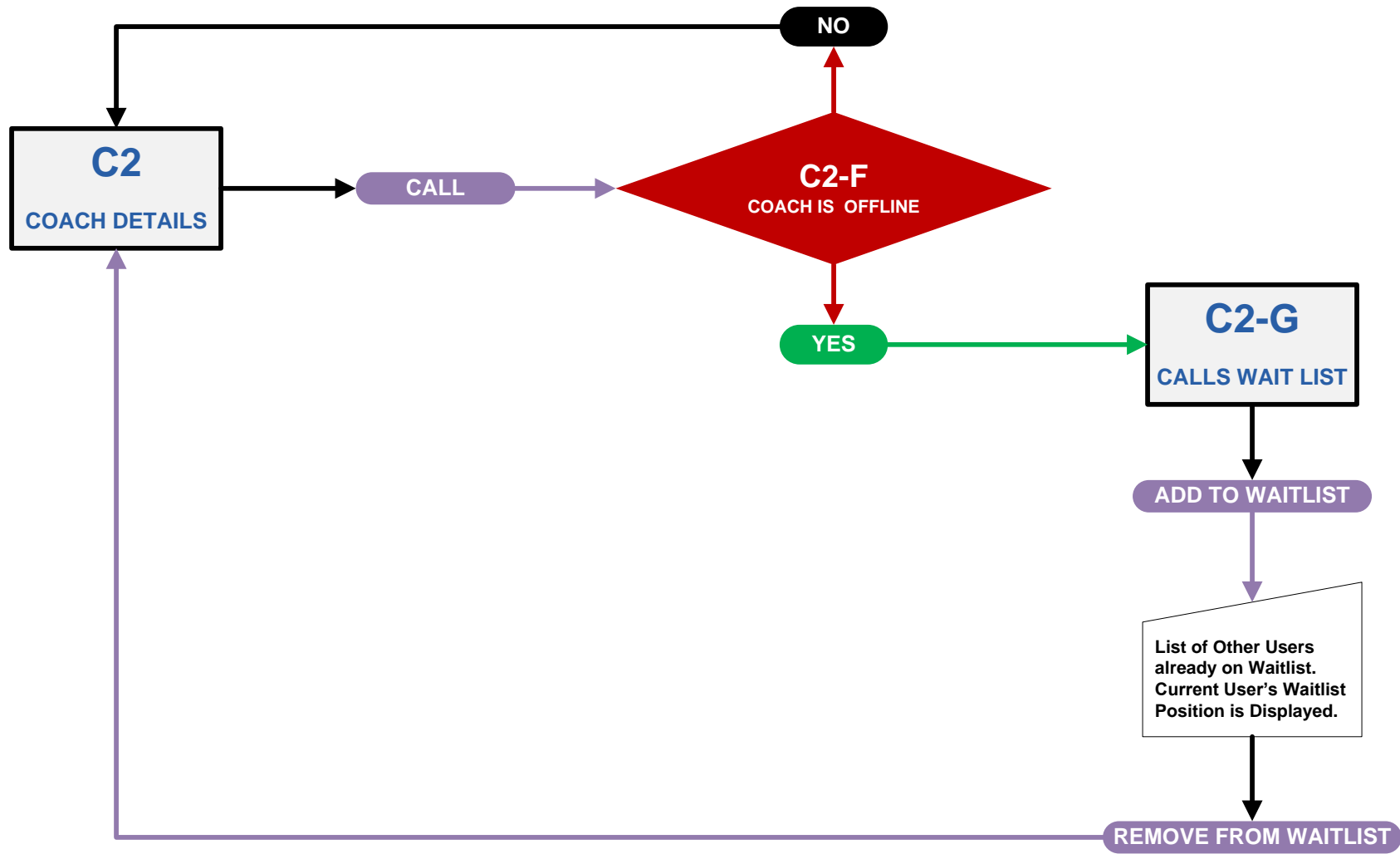

# FCS USER FLOWS

## User's Ratings Survey

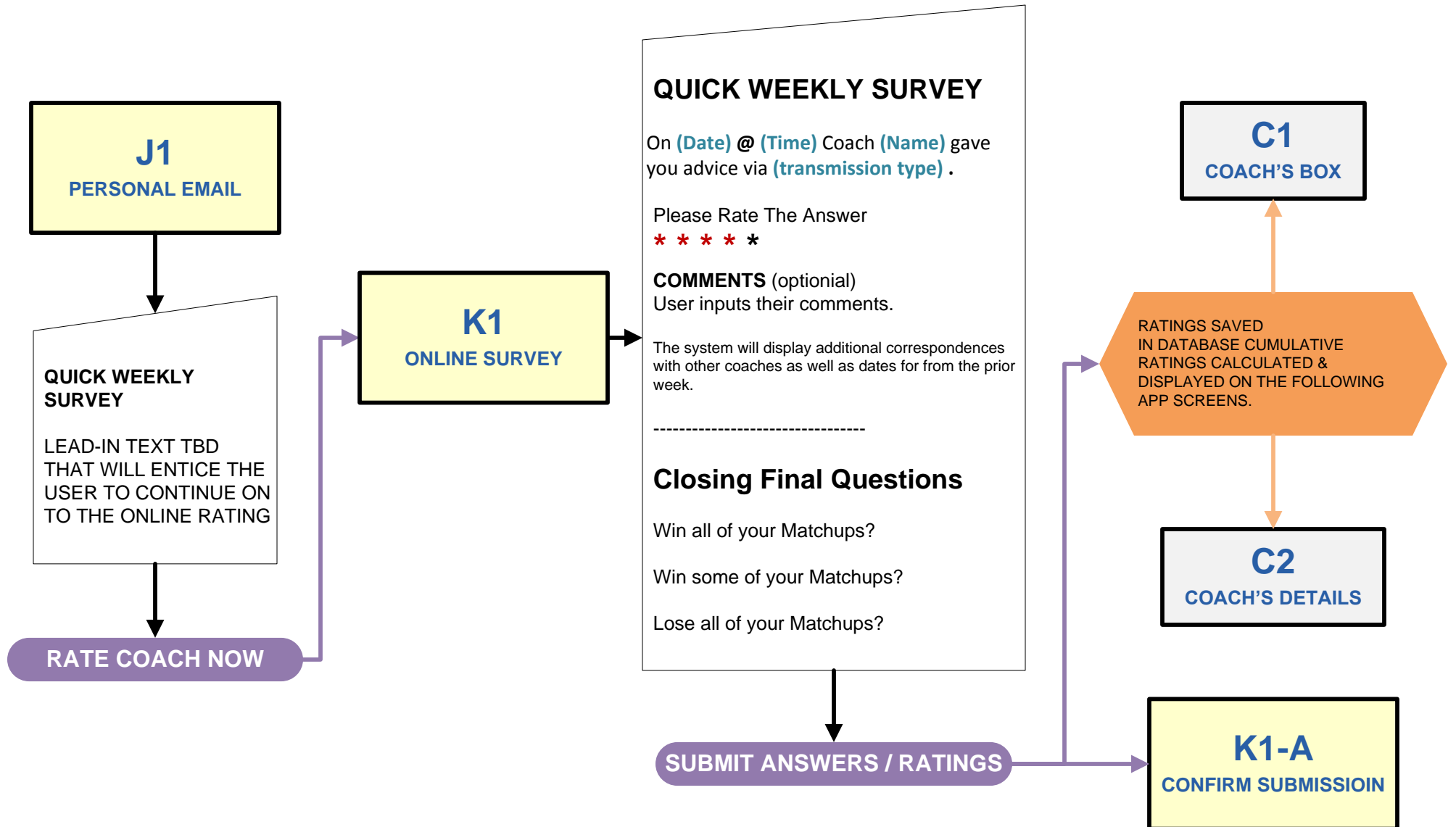

# FCS USER FLOWS

Responses

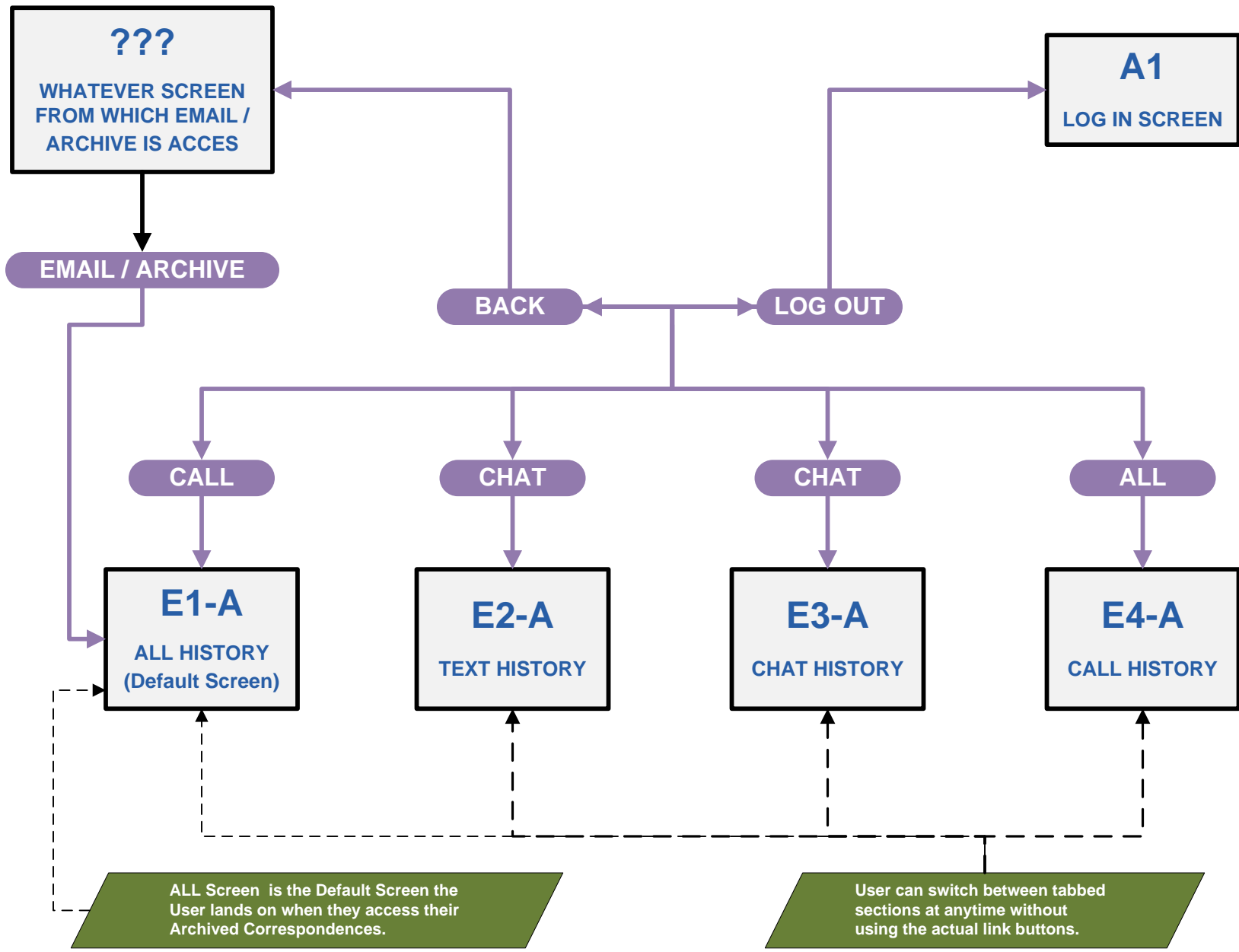

# FCS USER FLOWS

Responses

“ALL” Tabbed Section

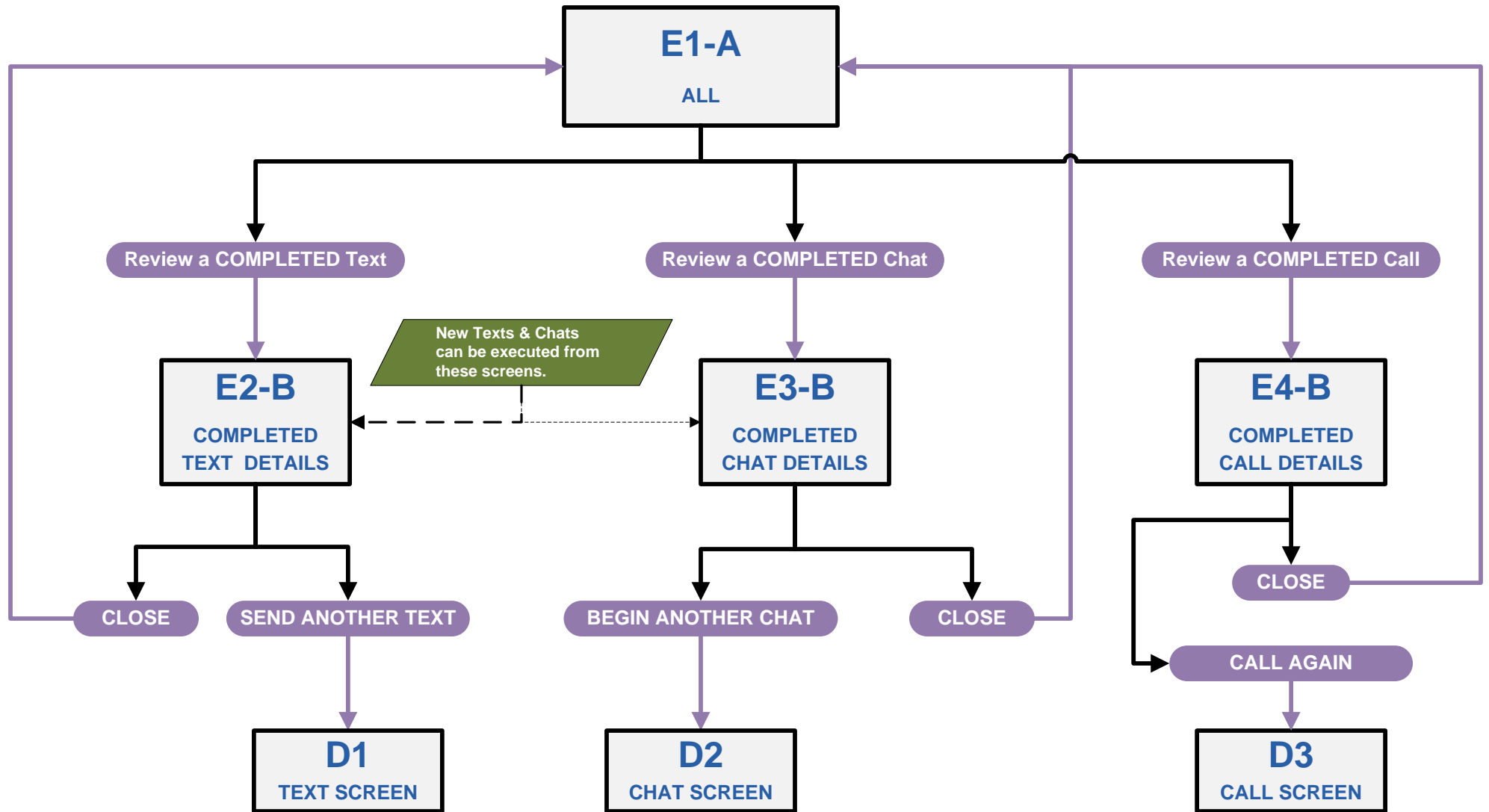

# FCS USER FLOWS

Responses

“TEXT” Tabbed Section

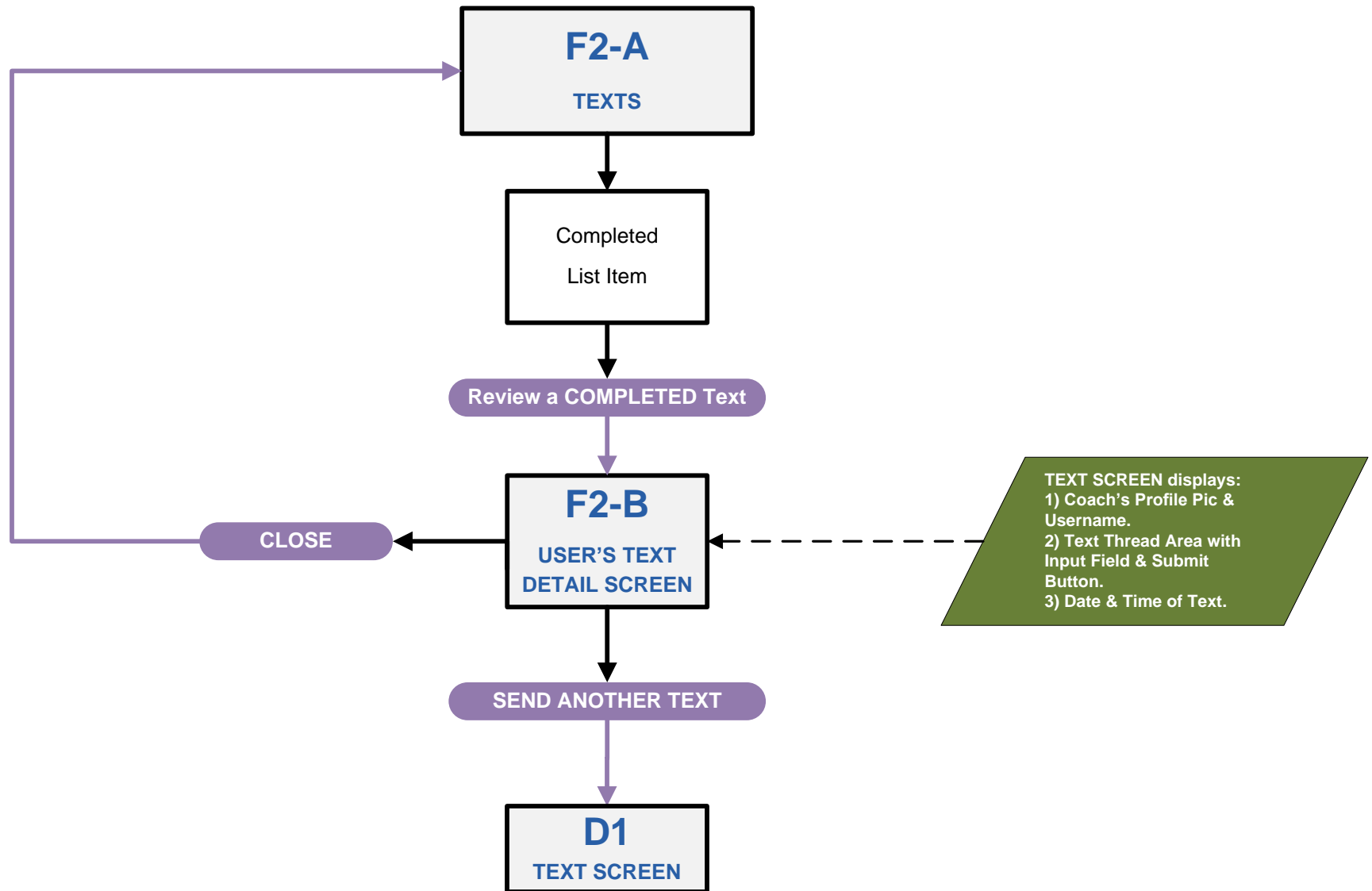

# FCS USER FLOWS

Responses

“CHAT” Tabbed Section

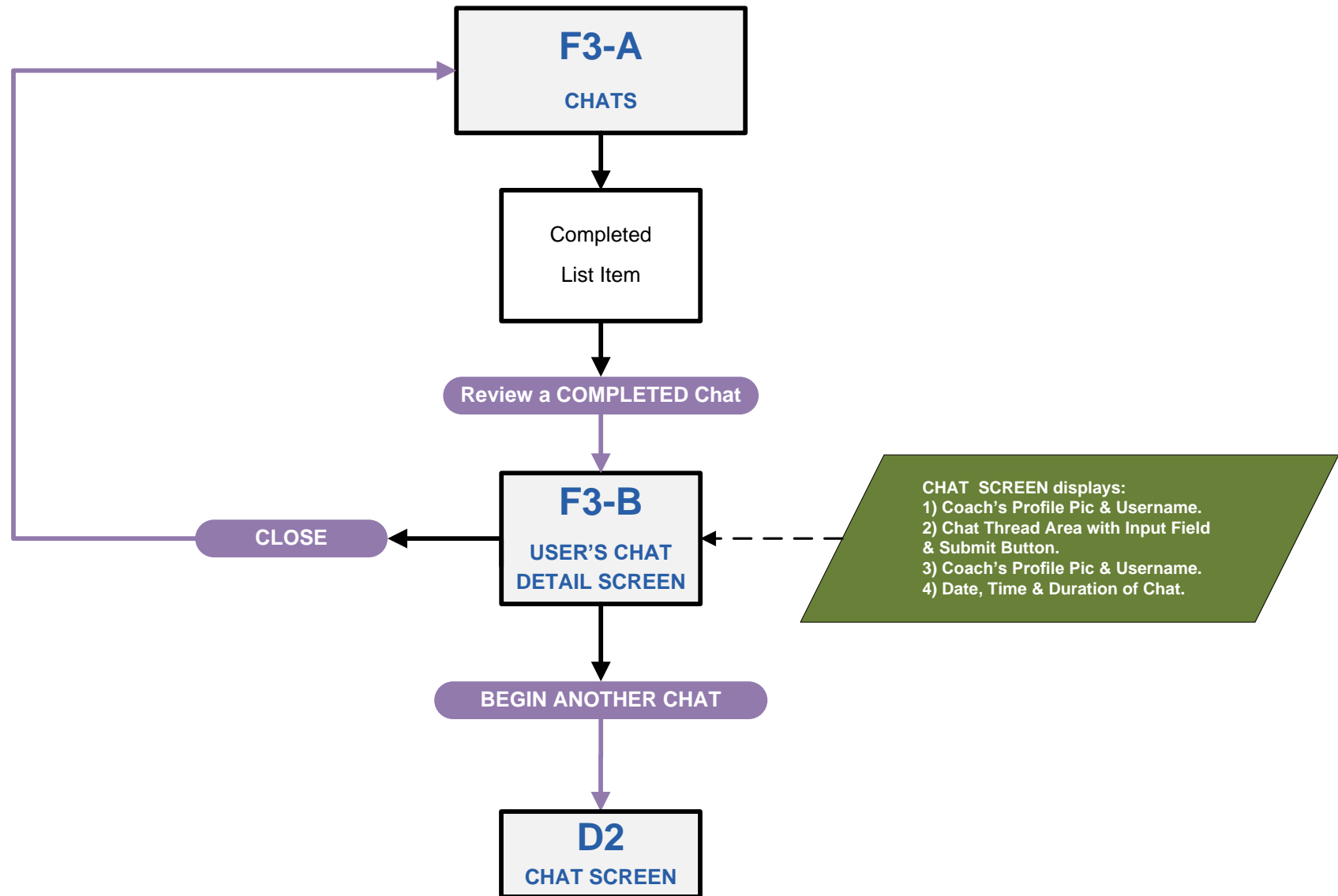

# FCS USER FLOWS

Responses

“CALL” Tabbed Section

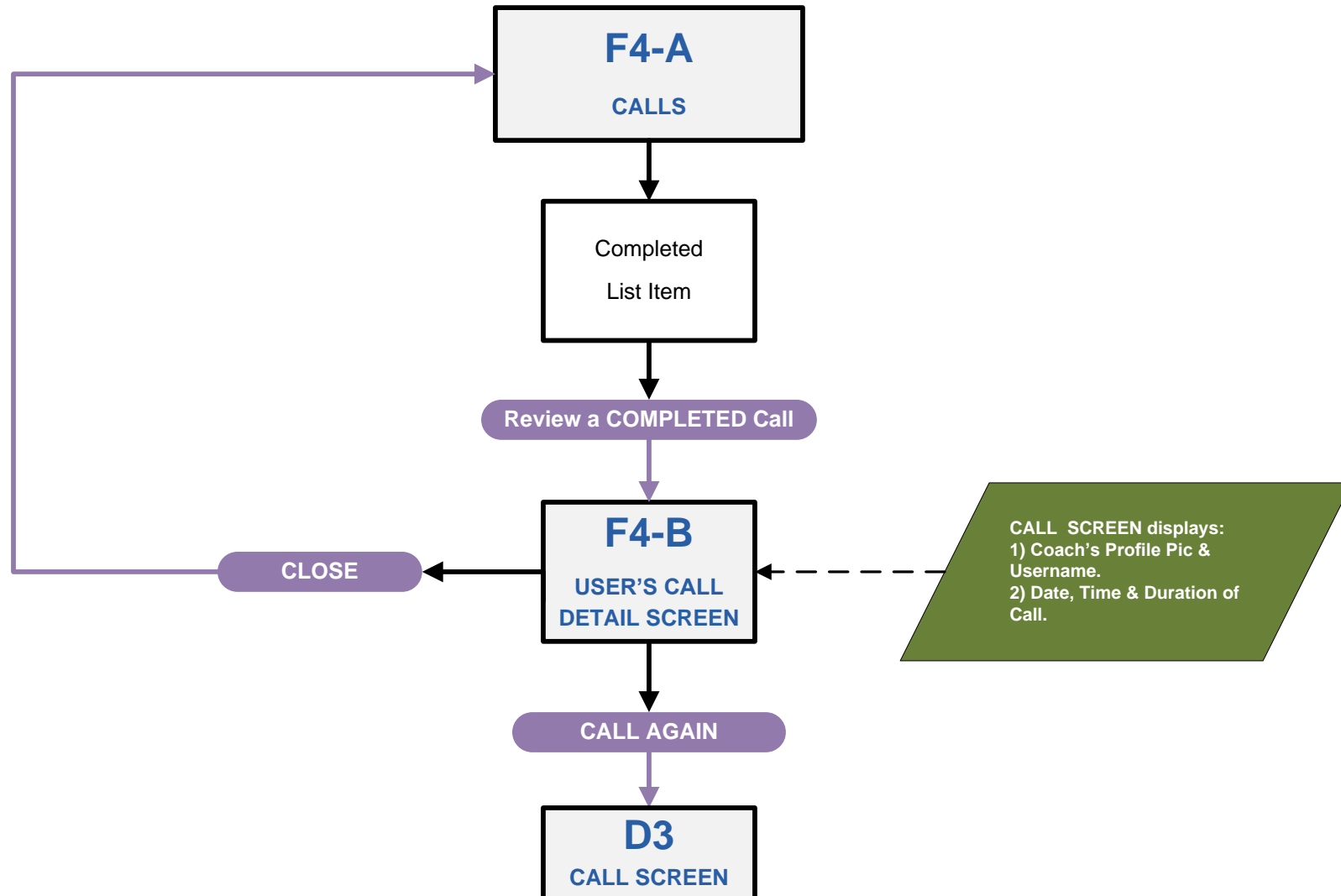



# FCS USER FLOWS

Application to be a Coach / Expert

## L1 ONLINE SURVEY

**User Initial Inquiry to becoming an Expert / Coach.**

- 1) Enter Email Address.
- 2) Full Name.
- 3) Address, City, State, Zip.
- 4) Phone.
- 5) # of Fantasy Leagues.
  - Football
  - Baseball
  - Basketball
  - Hockey
- 6) Are you an expert in all sports? If not, which ones are you an expert in?
- 7) Have you ever given fantasy sports to others. Please describe.
- 8) How many fantasy sports leagues have you won over the last 3 years. Please name them & type.
- 9) List all fantasy sports leagues you play in?
- 10) How many hours per week can you commit to being "online" and available to give fantasy sports advice?

**SUBMIT**

User can return to the Home / Landing Page, continue surfing the web or close out of the browser.

## L1-A CONFIRM SUBMISSION

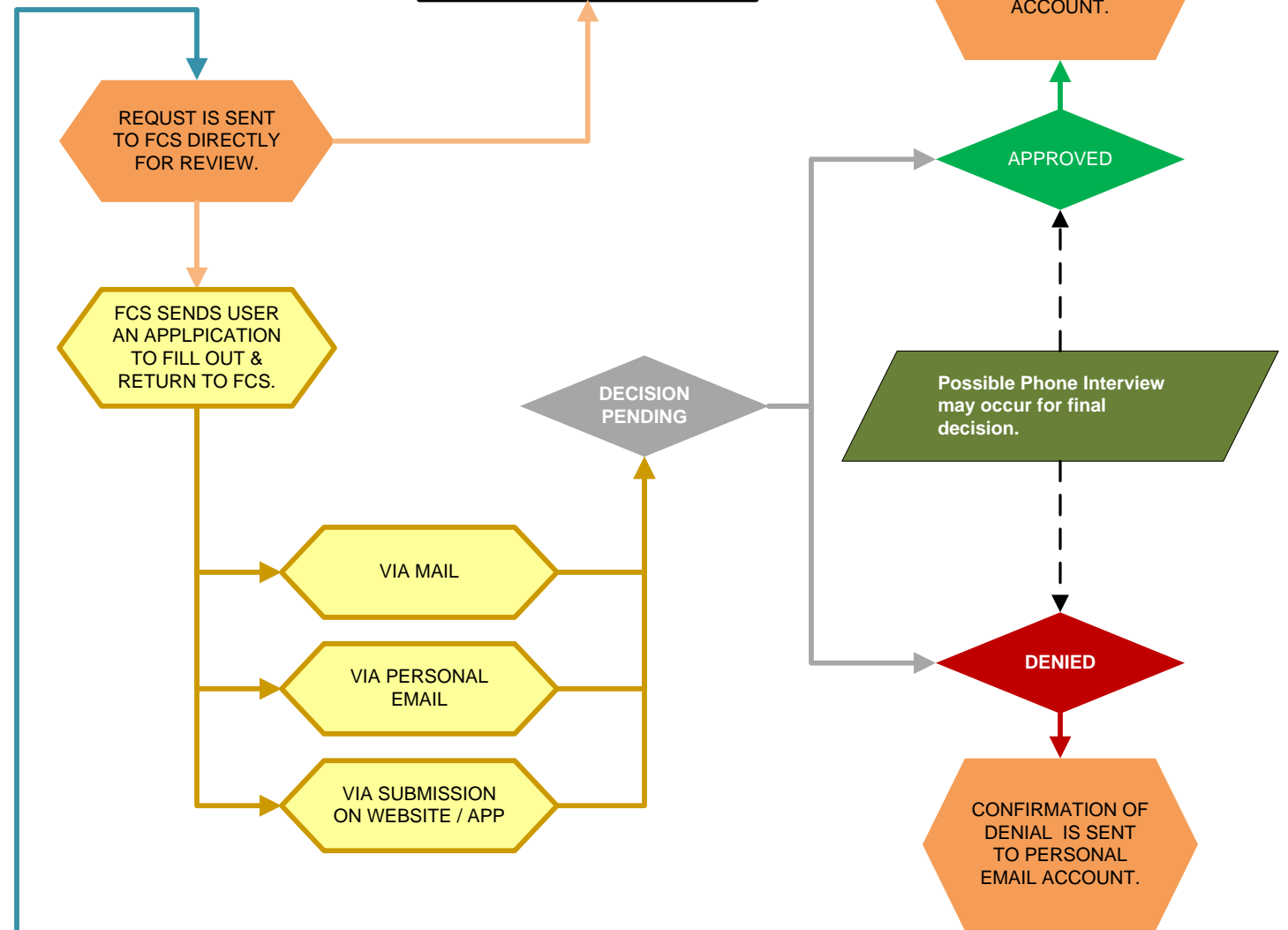

# FCS USER FLOWS

Coach's Dashboard

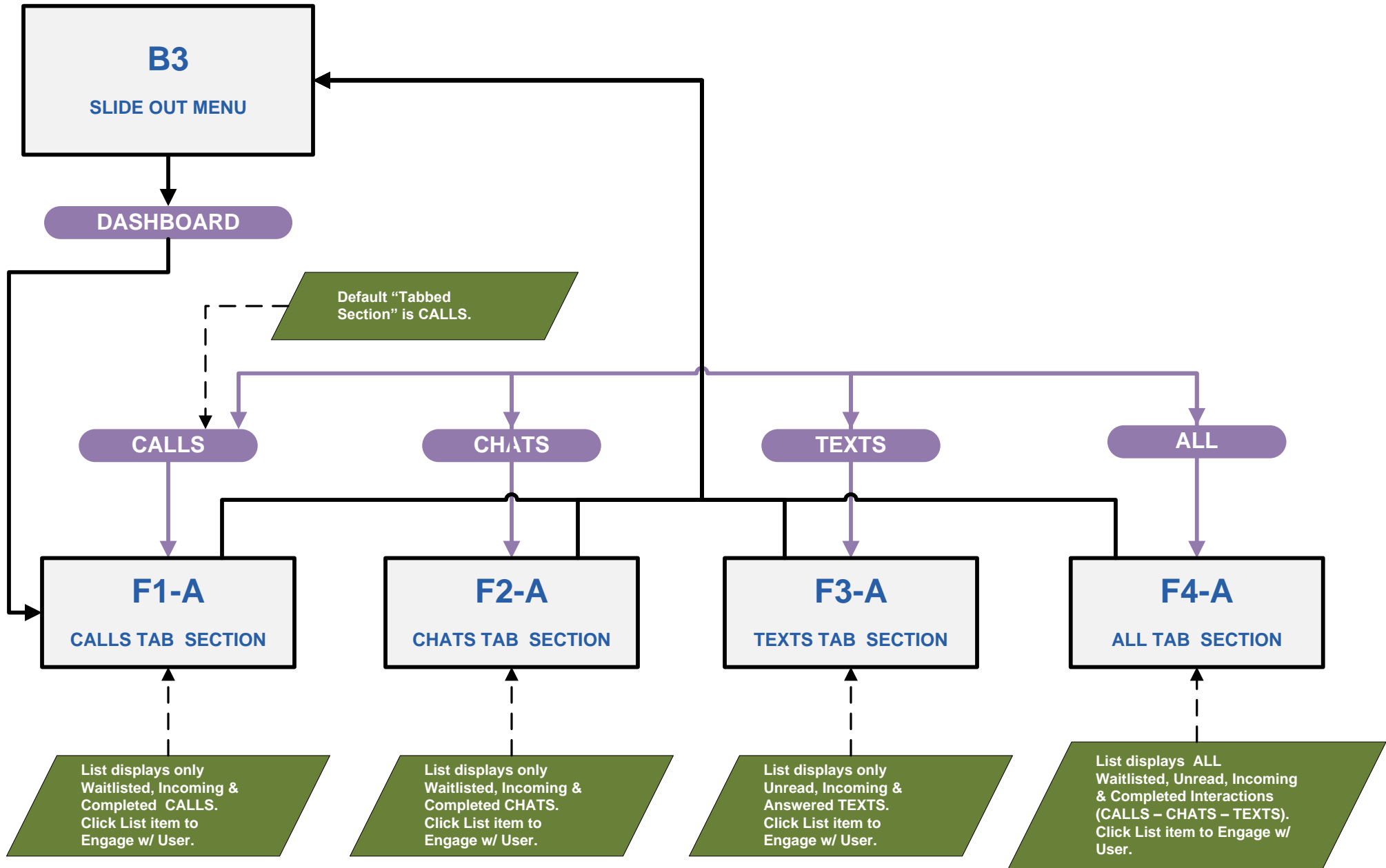

# FCS USER FLOWS

Coach's Dashboard

"Calls" Tabbed Section

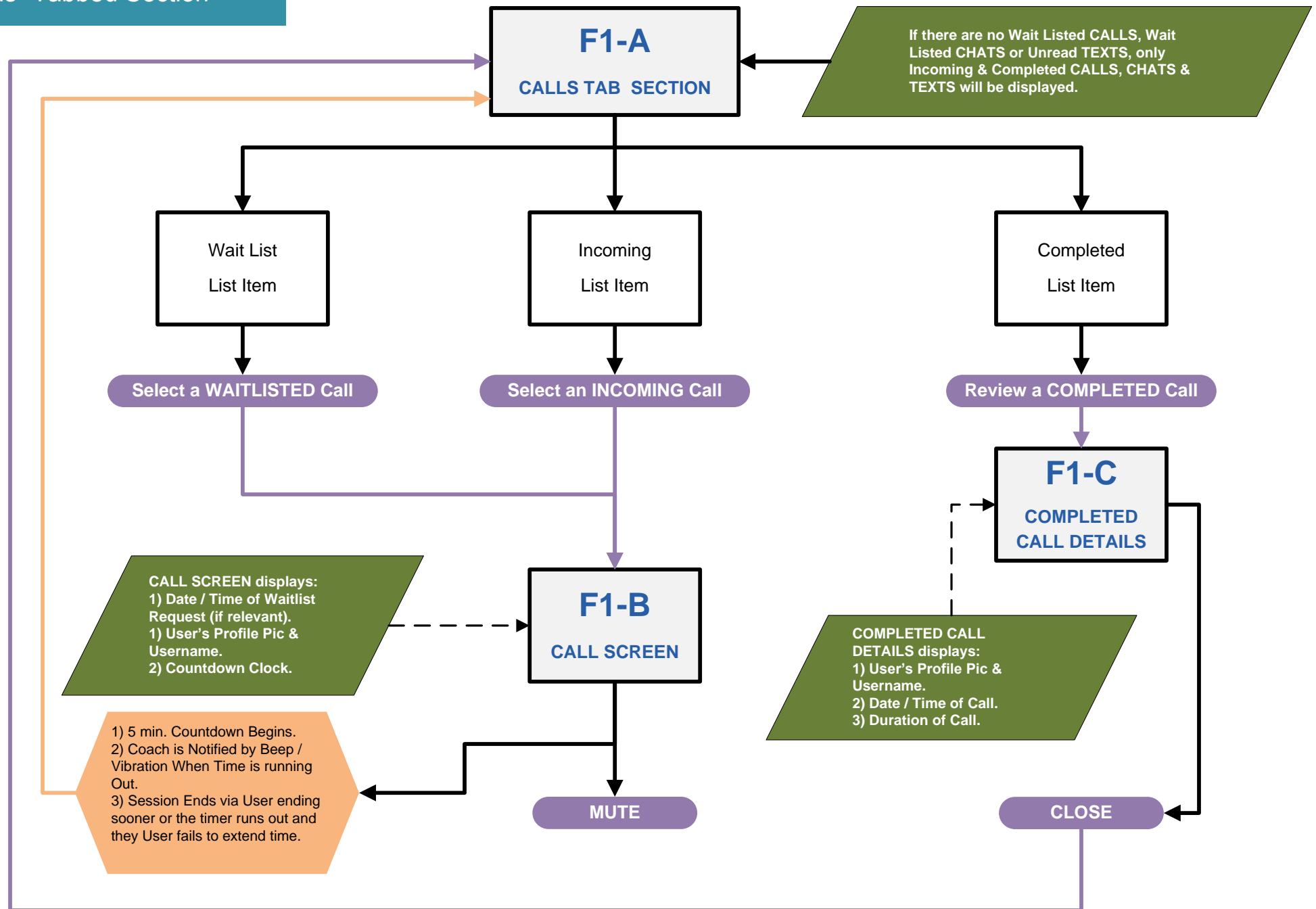

# FCS USER FLOWS

Coach's Dashboard

"Chats" Tabbed Section

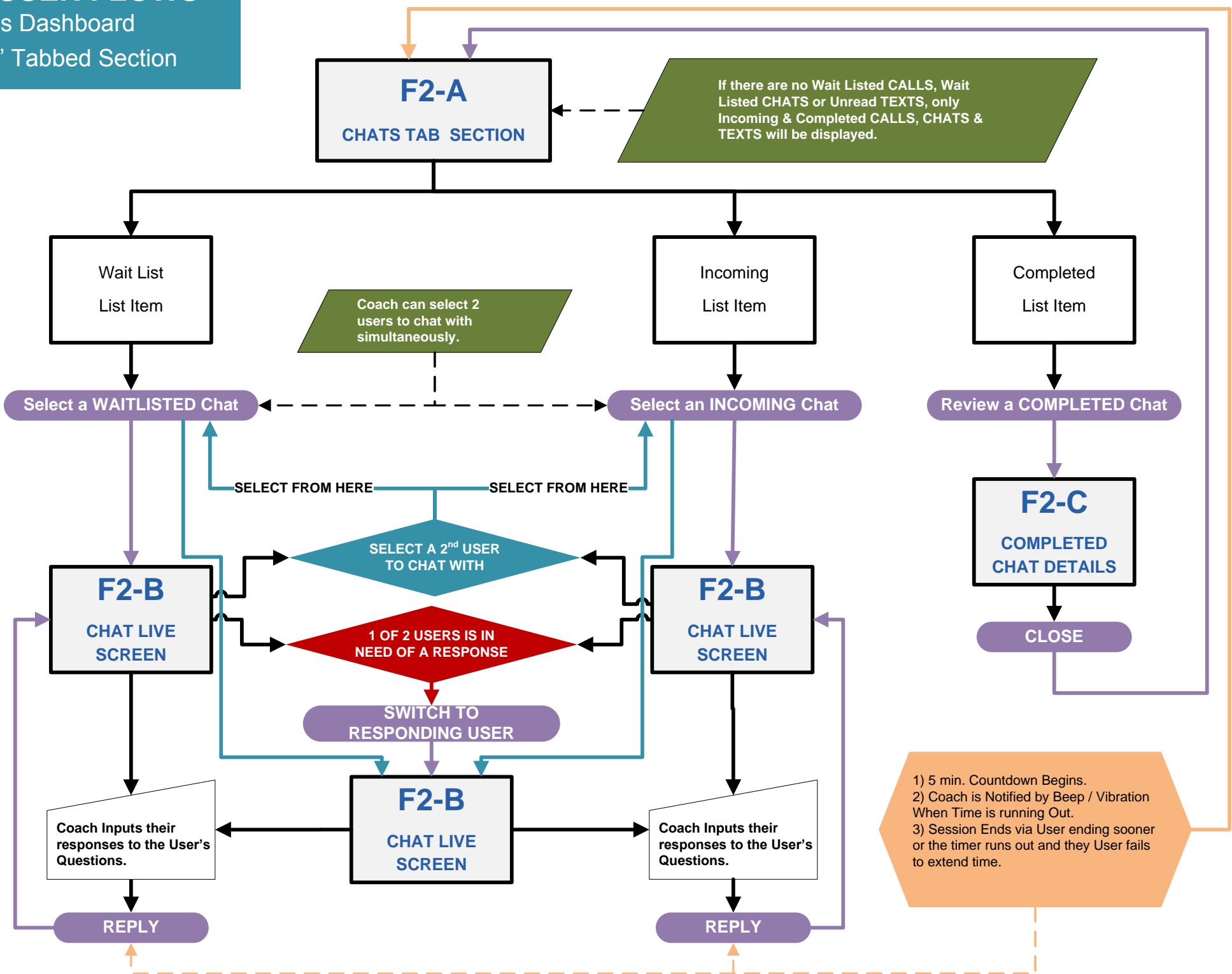

# FCS USER FLOWS

Coach's Dashboard

"Texts" Tabbed Section

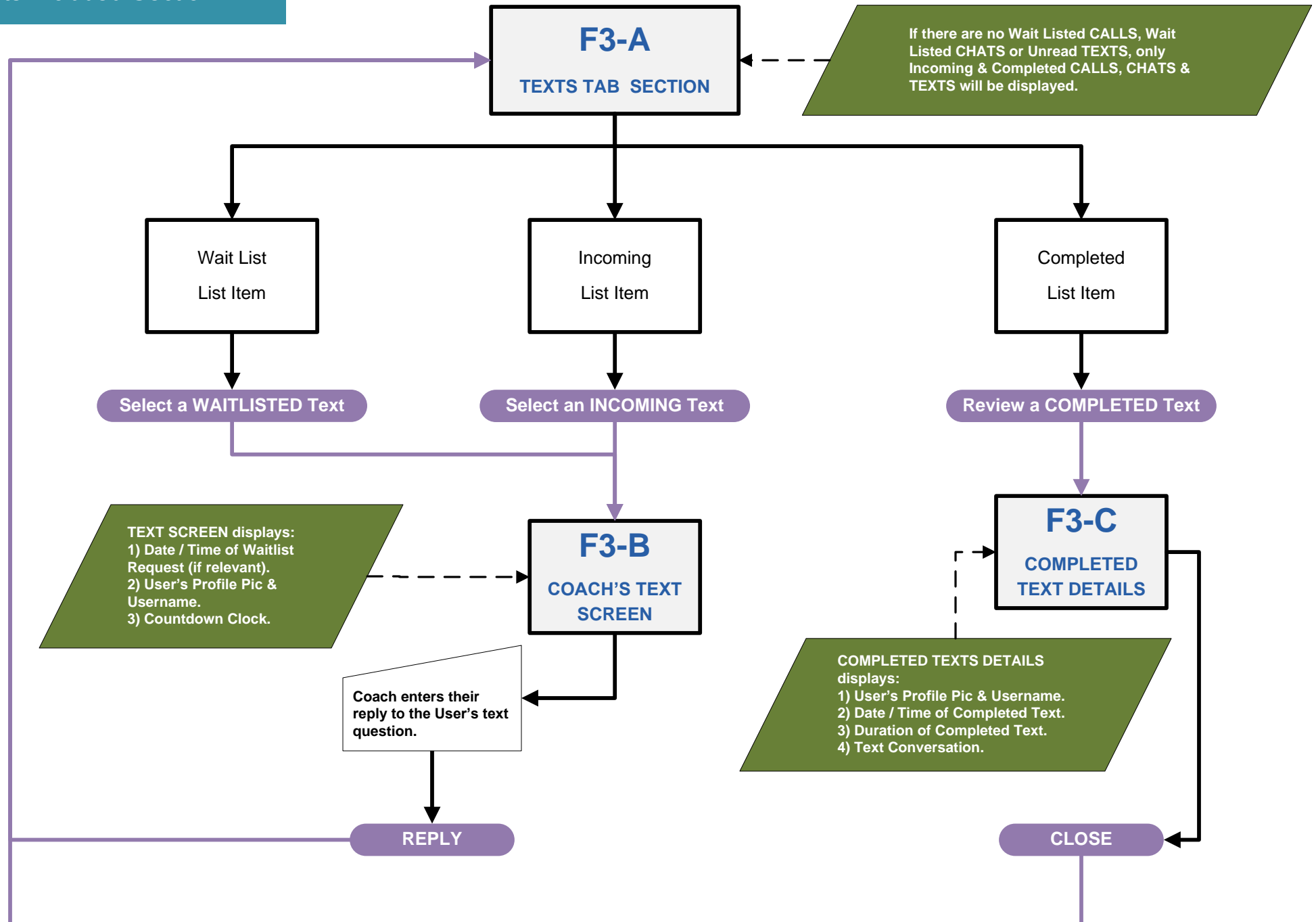

# FCS USER FLOWS

Coach's Dashboard

"All" Tabbed Section

